

# PRICE LIST

EFFECTIVE FEBRUARY 01, 2017



**HEAVY DUTY FOODWASTE DISPOSERS**

## **MASTER DISPOSERS**

165 Independence Court, Lancaster, PA 17601  
800-237-6628 ext. 173 • Fax: 717-299-4131  
*www.masterdisposers.com*

***QUALITY IS OUR PRIORITY***



**TABLE OF CONTENTS**

Warranty. . . . . 2

Terms of Sale. . . . . 3

Disposer Line-up . . . . . 4

Sizing/Selection Chart . . . . . 4

How to Order. . . . . 4

Disposers: Basic & Mounting Options

    “F” Series – 6" Rotor: 1/2 to 1 1/4 HP. . . . . 5

    “C” Series – 8" Rotor: 1 1/2 to 5 HP . . . . . 6

    “B” Series – 10 5/8" Rotor: 3 & 5 HP. . . . . 7

Controls: NEMA 4 Watertight . . . . . 8

Remote Start-Stop Switch . . . . . 9

Waterflow Components . . . . . 9

Disposer Options and Adaptor Kits . . . . . 9

Disposer Accessories. . . . . 10 & 11

**WARRANTY**

**THE MASTER DISPOSERS EXCLUSIVE ONE AND TEN YEAR WARRANTY ON F, C & B SERIES ONLY**  
**Product Confidence Unequaled in the Disposer Industry**

All products (and parts) manufactured and sold by MASTER DISPOSERS (the “Manufacturer”) are warranted to be free from defects in material and workmanship for a period of one year following the date of its initial installation or eighteen months from the date of shipment from the factory or factory warehouse, whichever expires first. Notice of a claim under this Warranty must be received by the Manufacturer at its offices before the expiration of such period in order for Warranty coverage of **PARTS AND LABOR** to apply.

If notice of a claim is timely made, the Manufacturer will repair or replace the product or part which is defective either at the user’s facility or at the Manufacturer’s plant, as the Manufacturer shall decide. In addition, the Manufacturer warrants that the basic body components of every Master Disposer will remain serviceable for a period of at least **TEN YEARS**. Should any of these basic body components require replacement during the first ten years of normal usage following installation the Manufacturer will furnish new duplicate parts to the original user at no charge. Manufacturer cannot warrant products returned to the factory not properly packaged, causing additional damage.

This Warranty shall not apply to the extent that products or parts have been used other than in conformance with operating and maintenance instructions, subjected to misuse or abuse or damaged by accident, act of God, abnormal use or stress or any other matter unrelated to the Manufacturer, and beyond its reasonable control or otherwise altered or modified by third parties. In addition, this Warranty does not cover normal wear items, such as sizing rings, impact bars and rotors. **THIS WARRANTY IS EXCLUSIVE AND IS IN LIEU OF ALL OTHER WARRANTIES, EXPRESSED AND IMPLIED, INCLUDING THE IMPLIED WARRANTIES OF MERCHANTABILITY AND FITNESS FOR PURPOSE.** In no event shall the Manufacturer be liable for loss of use, revenue or profit or for indirect or consequential damages.

All Master machines are packed in heavy corrugated shipping containers suitable for reshipment.

*Master Disposers is not responsible for any typographical errors.*

*Due to continued product improvement, specifications are subject to change without notice.*

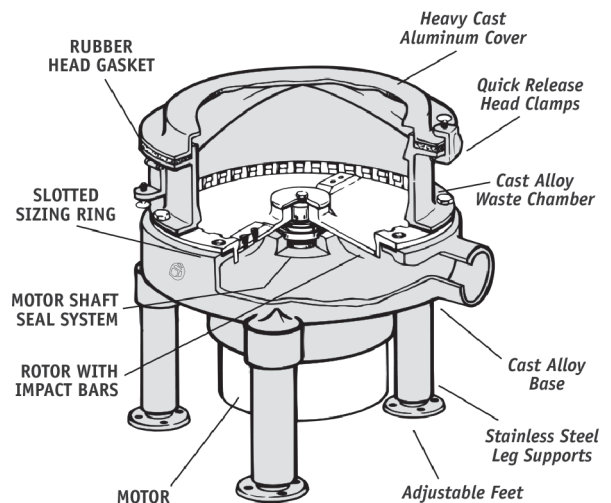

**STANDARD ONE YEAR WARRANTY**  
 ALL MASTER disposer components, shown above in **BLOCK** print, are guaranteed against all defects for the initial ONE YEAR period of use, as stated in the Warranty.

**MASTER DISPOSERS TEN YEAR WARRANTY**  
 ALL MASTER basic body components, shown above in **italicized** print, are guaranteed to remain serviceable for at least TEN YEARS, as stated in the Warranty.



## TERMS OF SALE

- 1. NATURE OF DOCUMENT.** This document constitutes the acceptance of the Master Disposers Division of Somat Company ("Seller") to sell the products specified on the reverse side (the "Products") on the terms and conditions contained herein, however, acceptance is made expressly conditional on the Buyer's agreement to all of the terms and conditions contained herein. Seller's acceptance of a purchase order from the Buyer shall not constitute acceptance of any of the terms and conditions thereon which differ from these terms, except as the Seller may otherwise specify in writing.
- 2. TERMINATION AND CANCELLATION.** Seller shall have the right to terminate and cancel the contract for sale of the Products at any time Seller determines that Buyer's credit is not satisfactory. Any such termination or cancellation shall be effective upon notification (orally or in writing) to Buyer and shall be without liability to the Seller. Under no circumstances shall Buyer have the right to terminate the contract or cancel its order to purchase the Products, without written authorization by the Seller. All cancelled orders and returned goods will be subject to a minimum of 25% cancellation and/or restocking charge. Custom or modified units cannot be returned.
- 3. PRICES.** Unless otherwise indicated, prices are F.O.B. Lancaster, PA and do not include any sales, use, excise or similar taxes or duties now or hereafter imposed. Errors or omissions in prices are subject to correction.
- 4. PAYMENT.** Unless otherwise indicated, payment terms are net cash 30 days from date of shipment. In the event that the Buyer fails to make payment on time, Buyer shall be liable to Seller for the lesser of (a) 1.5% per month on the remaining balance or (b) the highest monthly interest rate which may lawfully be charged to Buyer. Buyer shall be liable for all expenses (including reasonable attorneys' fees) incurred by Seller in collecting or attempting to collect any amounts due to Seller under the contract.
- 5. TITLE; RISK OF LOSS.** Title to, and risk of loss of, the Products shall pass to Buyer upon the delivery of the Products F.O.B. Lancaster, PA to an agent of Buyer or to a common carrier.
- 6. INSPECTION.** If, upon receipt of the Products by Buyer at the destination, the same shall appear not to conform to the order, Buyer shall within seven (7) days after receipt thereof, notify Seller of such condition and afford Seller a reasonable opportunity to inspect the Products and make the appropriate adjustments, repair or replacement. The remedies afforded under Section 7 below shall be exclusive for any defects discovered in the Products and which could have been discovered upon inspection. If the Seller is not so notified, the Buyer waives any recourse for those defects, and all warranty obligations of Seller regarding such obvious defects or deficiencies shall terminate.
- 7. LIMITED WARRANTIES AND REMEDIES.** Seller warrants that, at the time of shipment, the Products will be free from defects in material and workmanship for a period of one year from the date of purchase by the initial user. Written notice of a claim under this warranty must be received by Seller before the expiration of such period in order for warranty coverage to apply.  
If notice of a claim is timely made, Seller will repair or replace the Product or part which is defective (at Seller's sole option) either at the user's facility or at Seller's plant, as Seller shall decide. If Seller decides that a Product or part should be returned to its plant, the Buyer or user shall have the following obligations:
  - (a) removal of any parts to be returned;
  - (b) identification of all parts with tags stating the model number and serial number of the Products on which the part is used;
  - (c) shipment of Products and/or parts, transportation prepaid, to Seller's plant;
  - (d) installation of the repaired or replaced Product or parts at user's facility.This Warranty shall not apply to the extent that Products or parts have been used other than in conformance with operating or maintenance instructions, subjected to misuse or abuse, damaged by accident, act of God, abnormal use or stress or any other matter unrelated to Seller and beyond its reasonable control or altered or modified by third parties.  
THIS WARRANTY IS EXCLUSIVE AND IS IN LIEU OF ALL OTHER WARRANTIES, EXPRESS OR IMPLIED, INCLUDING THE IMPLIED WARRANTY OF MERCHANTABILITY AND FITNESS FOR PURPOSE. IN NO EVENT SHALL THE COMPANY BE LIABLE FOR LOSS OF USE, REVENUE OR PROFIT OR FOR ANY OTHER INCIDENTAL, SPECIAL OR CONSEQUENTIAL DAMAGE INVOLVING THE PRODUCTS.
- 8. LIMITATION OF LIABILITY.** The liability of Seller arising out of the manufacture, sale, delivery, repair, or use of any of the Products shall not, in any event, exceed the cost of correcting defects or making replacement as required in the Limited Warranty and, upon the expiration of the Limited Warranty, all liability of Seller to Buyer shall terminate.
- 9. DELAYS.** Neither party shall be liable for any delay or failure to perform any obligation to the other if such delay or failure shall be caused by an event or contingency beyond its reasonable control, irrespective of the nature thereof, however, the delaying party shall endeavor to correct such delay as soon as reasonably practicable.
- 10. MODIFICATION; ASSIGNMENT; APPLICABLE LAW; ENTIRE AGREEMENT.** No modification of the terms and conditions specified in the contract shall be binding upon Seller unless agreed to by Seller in writing. The contract shall not be assigned by Buyer, nor may any of the duties of Buyer thereunder be delegated, without the written consent of Seller. Any such assignment or delegation without such consent shall be void. The contract shall be governed by, and construed in accordance with, the laws of the State of Pennsylvania. The provisions of the contract shall constitute the entire agreement of the parties with respect to the sale of the Products by Seller to Buyer and shall supersede all prior discussion and writings between the parties.
- 11. BINDING EFFECT OF CONTRACT.** The contract shall be binding upon, and shall inure to the benefit of, the parties hereto and their respective successors and assigns.
- 12. RETURNS.** No returns will be accepted without the prior approval of the Seller. A Return Authorization Number must be given by Seller prior to Products being shipped, freight prepaid, by Buyer. Any damage in transit to Products being returned is Buyer's responsibility. All accepted returns are subject to a 25% or \$25.00 minimum restocking charge. Returns that have been approved by Seller must be received within thirty (30) days after approval. Returns will not be considered after ninety (90) days from date of original notice.
- 13. INDEMNITY.** Buyer agrees to indemnify, hold harmless and defend Seller from and against any and all liabilities and expenses arising out of any injury or damage which results from Buyer's use, misuse, misapplication, failure to inspect, maintain or repair the Products which are the subject of this agreement.
- 14. MINIMUM ORDER.** \$75.00 net.

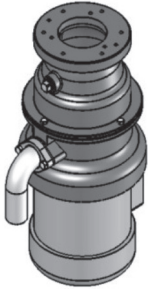
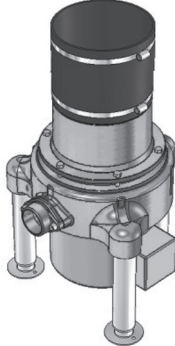
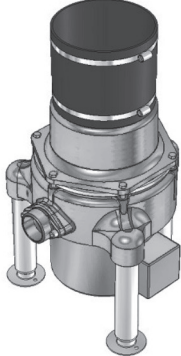

**DISPOSER LINE-UP**

			
	<b>"F" SERIES</b>	<b>"C" SERIES</b>	<b>"B" SERIES</b>
<b>Disposing Rate (Lbs./Hr.)</b>	300	900	1,500
<b>Rotor Diameter (Inches)</b>	6	8	10 <sup>3</sup> / <sub>8</sub>
<b>Horsepower Sizes</b>	1/2, 3/4, 1 <sup>1</sup> / <sub>4</sub>	1 <sup>1</sup> / <sub>2</sub> , 2, 3, 5	3, 5
<b>Throat Opening (Inches)</b>	4 <sup>1</sup> / <sub>2</sub>	8 <sup>3</sup> / <sub>4</sub>	8 <sup>3</sup> / <sub>4</sub>
<b>Offset Throat Models</b>	NO	YES	YES

**SIZING / SELECTION CHART**

<p><i>Use This Chart to Determine the Correct Disposer for Your Needs</i></p>	<b>RECOMMENDED APPLICATION</b>							
	Churches Caterers Private Clubs Convenience Stores Bed & Breakfast Inns Airport Snack Bars Salad Sinks	Schools Health Clubs Small Kitchens Vegetable Prep. Areas Nursing Care Facilities Salad Prep. Areas Pot Sinks	Cafeterias Hospitals Universities Steak Houses Ship's Galleys Central Shipping Areas Pre-Rinse Sinks	Hotels Supermarkets Commissaries Cruise Ships Large Restaurants Resort Banquet Halls Central Dishwashers				
	<b>RECOMMENDED SERIES AND HORSEPOWER</b>							
<b>MEALS PER HOUR</b>	<b>SERIES</b>	<b>HP</b>	<b>SERIES</b>	<b>HP</b>	<b>SERIES</b>	<b>HP</b>	<b>SERIES</b>	<b>HP</b>
75	F	1/2	F	3/4	-	-	-	-
150	F	3/4	F	3/4	-	-	-	-
300	F	3/4	F	1 <sup>1</sup> / <sub>4</sub>	C	1 <sup>1</sup> / <sub>2</sub>	-	-
500	F	1 <sup>1</sup> / <sub>4</sub>	F	1 <sup>1</sup> / <sub>4</sub>	C	1 <sup>1</sup> / <sub>2</sub>	-	-
900	-	-	C	1 <sup>1</sup> / <sub>2</sub>	C	3	B	3
1,500	-	-	C	2	C	5	B	5
2,000	-	-	C	3	B	3	B	5
2,800	-	-	-	-	B	5	-	-
3,500	-	-	-	-	-	-	-	-
4,400	-	-	-	-	-	-	-	-
6,000	-	-	-	-	-	-	-	-

**HOW TO ORDER**

**Step 1:** Choose Basic Disposer model number.

**Step 2:** Choose Mounting Assembly Option (Sink or Cone).

**Step 3:** Choose Switch or Control Center from page 8 or 9.

**EXAMPLE:**

<b>F114S-L</b>	Basic Disposer .....	<b>\$2,771.00</b>
<b>D-BC18</b>	Mounting Assembly .....	<b>\$ 977.00</b>
<b>MS-1</b>	Switch.....	<b>\$ 297.00</b>
<b>Total Cost.....</b>		<b>\$4,045.00</b>

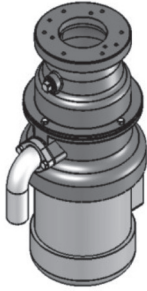
"F" SERIES – 6" ROTOR		FREIGHT CLASS 65	
		<b>Includes:</b> <ul style="list-style-type: none"> <li>• 6 Mounting Bolts</li> <li>• Splash Guard Gasket</li> <li>• Phases, Voltages and Hertz               <ul style="list-style-type: none"> <li>1 Phase: 115/230V, 60Hz</li> <li>3 Phase: 208-230/460V, 60Hz</li> </ul> </li> </ul>	
MODEL NO.	DESCRIPTION	SHIP WT. LBS.	LIST PRICE
F12-L	1/2 HP, 3 Phase, 4 1/2" Throat Size	55	\$1,984.00
F12S-L	1/2 HP, 1 Phase, 4 1/2" Throat Size	55	\$1,984.00
F34-L	3/4 HP, 3 Phase, 4 1/2" Throat Size	55	\$2,301.00
F34S-L	3/4 HP, 1 Phase, 4 1/2" Throat Size	55	\$2,301.00
F114-L	1 1/4 HP, 3 Phase, 4 1/2" Throat Size	60	\$2,771.00
F114S-L	1 1/4 HP, 1 Phase, 4 1/2" Throat Size	60	\$2,771.00
	<ul style="list-style-type: none"> <li>• 1 Phase 115/230V, 60Hz or 110/220V, 50Hz</li> <li>• 3 Phase 208-230/460V, 60Hz or 190-220/380-440V, 50Hz</li> </ul>		
<b>FOR NEW INSTALLATION:</b> For complete assembly in a new installation, Mounting Assembly, Switch or Control Center must be added to the Basic Disposer. Sink or Cone Assembly choices are listed below and Switch or Control Center choices are listed on pages 8 and 9.			

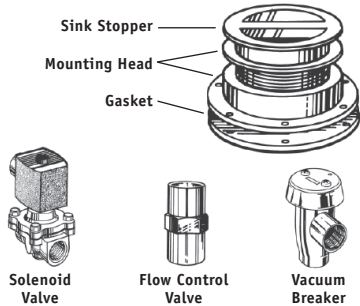
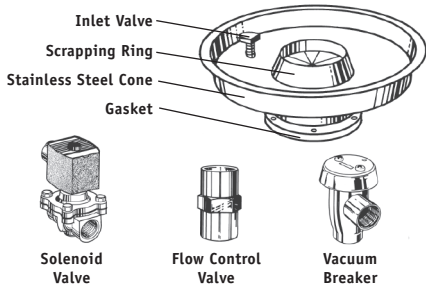
"F" SERIES – 6" ROTOR, ASSEMBLY OPTIONS		FREIGHT CLASS 65	
SINK ASSEMBLY			
 <p>Sink Stopper Mounting Head Gasket</p> <p>Solenoid Valve      Flow Control Valve      Vacuum Breaker</p>		For regular sink attachment. Suspend from standard sink having a 3 1/2" to 4" diameter sink opening. <b>Includes:</b> <ul style="list-style-type: none"> <li>• Mounting Head and Gaskets</li> <li>• Sink Stopper</li> <li>• 1/2" Solenoid Valve (specify voltage)</li> <li>• 3 GPM Flow Control Valve</li> <li>• 1/2" Vacuum Breaker</li> </ul>	
MODEL NO.	DESCRIPTION	SHIP WT. LBS.	LIST PRICE
D-SK4	Sink Assembly	8	\$659.00
CONE ASSEMBLY			
 <p>Inlet Valve Scrapping Ring Stainless Steel Cone Gasket</p> <p>Solenoid Valve      Flow Control Valve      Vacuum Breaker</p>		For regular cone attachment. Suspends from cone welded to dishtable. <b>Includes:</b> <ul style="list-style-type: none"> <li>• Stainless Steel Cone (choice of 12", 15" or 18") and Gasket</li> <li>• Water Swirl Inlet Valve</li> <li>• Vinyl Silver Saver Scrapping Ring</li> <li>• 1/2" Solenoid Valve (specify voltage)</li> <li>• 3 GPM Flow Control Valve</li> <li>• 1/2" Vacuum Breaker</li> </ul>	
MODEL NO.	DESCRIPTION	SHIP WT. LBS.	LIST PRICE
D-BC12	12" Cone Assembly	18	\$977.00
D-BC18	18" Cone Assembly	18	\$977.00

**"C" SERIES – 8" ROTOR**

FREIGHT CLASS 65

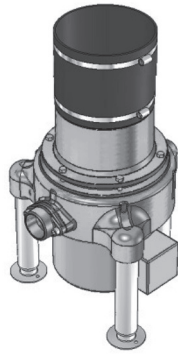
**Includes:**

- 8 1/4" x 9" long Flexible Neoprene Connector Sleeve
- 2 Stainless Steel Clamps
- Phases, Voltages and Hertz
  - 1 Phase: 115/230V, 60Hz
  - 3 Phase: 208-230/460V, 60Hz

MODEL NO.	DESCRIPTION	SHIP WT. LBS.	LIST PRICE
C112-L	1 1/2 HP, 3 Phase, Specify 8 1/4" Throat Size	117	\$4,275.00
C112S-L	1 1/2 HP, 1 Phase, Specify 8 1/4" Throat Size	120	\$4,275.00
C2-L	2 HP, 3 Phase, Specify 8 1/4" Throat Size	130	\$4,575.00
C2S-L	2 HP, 1 Phase, Specify 8 1/4" Throat Size	132	\$4,575.00
C3-L	3 HP, 3 Phase, Specify 8 1/4" Throat Size	158	\$4,879.00
C5-L	5 HP, 3 Phase, Specify 8 1/4" Throat Size	47	\$6,114.00
	<b>OFFSET DESIGN:</b> For Offset Drum Option (8 1/4" Throat Size) replace -L with <b>-0</b> at end of model number.	<i>Add</i> 25	\$896.00

**FOR NEW INSTALLATION:** For complete assembly in a new installation, Mounting Assembly, Switch or Control Center must be added to the Basic Disposer. Sink or Cone Assembly choices are listed below and Switch or Control Center choices are listed on pages 8 and 9.

**"C" SERIES – 8" ROTOR, ASSEMBLY OPTIONS**

FREIGHT CLASS 65

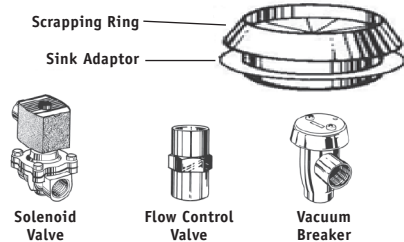
**SINK ASSEMBLY**

For regular sink attachment. Adjustable leg support.

**Includes:**

- Stainless Steel Sink Adaptor Ring
- Vinyl Silver Trap Scrapping Ring
- 1/2" Solenoid Valve (specify voltage)
- 8 GPM Flow Control Valve
- 1/2" Vacuum Breaker
- Water Swirl Inlet

MODEL NO.	DESCRIPTION	SHIP WT. LBS.	LIST PRICE
C-SK8	Sink Assembly for 8 1/4" Diameter Throat Size	5	\$684.00

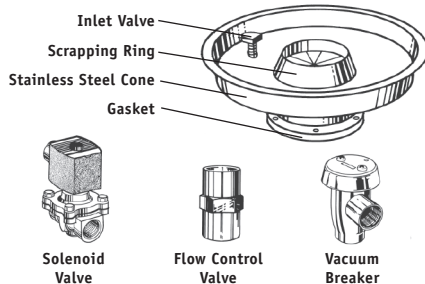
**CONE ASSEMBLY**

For regular cone attachment. Adjustable leg support.

**Includes:**

- Stainless Steel Cone (choice of 12" or 18")
- Water Swirl Inlet Valve
- Vinyl Silver Saver Scrapping Ring
- 1/2" Solenoid Valve (specify voltage)
- 8 GPM Flow Control Valve
- 1/2" Vacuum Breaker

MODEL NO.	DESCRIPTION	SHIP WT. LBS.	LIST PRICE
	<b>For 8 1/4" Throat Size:</b>		
C-BC12	12" Cone Assembly	18	\$991.00
C-BC18	18" Cone Assembly	18	\$991.00



**"B" SERIES – 10<sup>5</sup>/<sub>8</sub>" ROTOR** **FREIGHT CLASS 65**

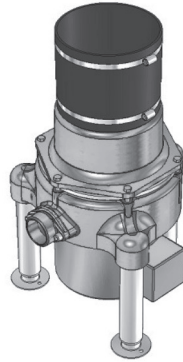

- Includes:**
- 8<sup>1</sup>/<sub>4</sub>" dia. x 9" long Flexible Neoprene Connector Sleeve
  - 2 Stainless Steel Clamps
  - All 8<sup>1</sup>/<sub>4</sub>" Diameter Throat Size
  - Phases, Voltages and Hertz  
208-230/460V, 60Hz  
190/380V, 50Hz

MODEL NO.	DESCRIPTION	SHIP WT. LBS.	LIST PRICE
B3-L	3 HP, 3 Phase	210	\$7,042.00
B5-L	5 HP, 3 Phase	220	\$7,622.00
	<b>OFFSET DESIGN:</b> For Offset Drum Option replace -L with <b>-0</b> at end of model number. <span style="float: right;"><i>Add</i></span>	35	\$779.00

**FOR NEW INSTALLATION:** For complete assembly in a new installation, Mounting Assembly, Switch or Control Center must be added to the Basic Disposer. Sink or Cone Assembly choices are listed below and Switch or Control Center choices are listed on pages 8 and 9.

**"B" SERIES – 10<sup>5</sup>/<sub>8</sub>" ROTOR, ASSEMBLY OPTIONS** **FREIGHT CLASS 65**

**SINK ASSEMBLY**

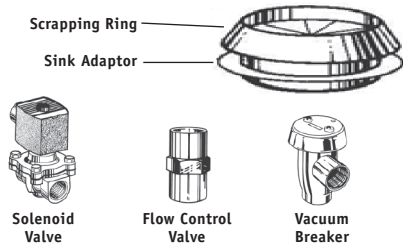

- For regular sink attachment. Adjustable leg support.
- Includes:**
- Stainless Steel Sink Adaptor Ring
  - Vinyl Silver Trap Scrapping Ring
  - 1/2" Solenoid Valve (specify voltage)\*
  - 3 GPM Flow Control Valve
  - 10 GPM Flow Control Valves
  - 1/2" Vacuum Breaker\*
  - Water Swirl Inlet

\* For 3/4" option, see page 9.

MODEL NO.	DESCRIPTION	SHIP WT. LBS.	LIST PRICE
AB-SK8	Sink Assembly	6	\$848.00

**CONE ASSEMBLY**

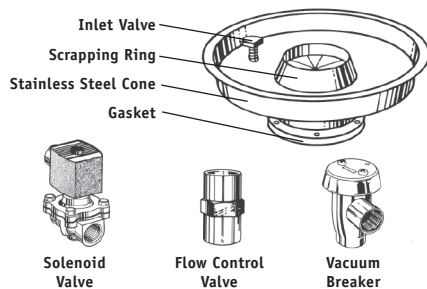

- For regular cone attachment. Adjustable leg support.
- Includes:**
- Stainless Steel Cone (choice of 12", 15" or 18")
  - Water Swirl Inlet Valve
  - Vinyl Silver Saver Scrapping Ring
  - 1/2" Solenoid Valve (specify voltage)\*
  - 3 GPM Flow Control Valve
  - 10 GPM Flow Control Valves
  - 1/2" Vacuum Breaker\*

\* For 3/4" option, see page 9.

MODEL NO.	DESCRIPTION	SHIP WT. LBS.	LIST PRICE
AB-BC12	12" Cone Assembly	18	\$1,115.00
AB-BC18	18" Cone Assembly	18	\$1,115.00



## CONTROLS: NEMA 4 WATERTIGHT

### ON-OFF SWITCHES – Non-Reversing

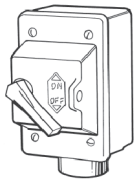

Manual Contact

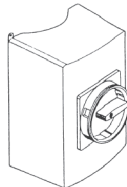

Magnetic Contactor

*Specify HP, Voltage and Phase when ordering*

MODEL NO.	DESCRIPTION	SHIP WT. LBS.	LIST PRICE
MS-1	½ to 2 HP Range, 1 Phase	4	\$297.00
MS-2	½ to 2 HP Range, 3 Phase	4	\$297.00
<b>MAGNETIC CONTACTOR:</b>			
MC	½ to 10 HP Range	3	\$540.00

### ON-OFF SWITCHES – Manual Reversing

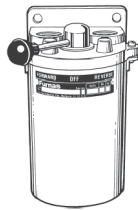

Drum Switch

*Specify HP, Voltage and Phase when ordering*

MODEL NO.	DESCRIPTION	SHIP WT. LBS.	LIST PRICE
<b>DRUM SWITCH:</b>			
RMS-2	½ to 1½ HP, 115 Volts, 1 Phase ½ to 2 HP, 230 Volts, 1 Phase ½ to 2 HP, 208-230/460 Volts, 3 Phase	3	\$1,077.00
RMS-3	3 HP, 208-230/460 Volts, 3 Phase	5	\$1,168.00
RMS-5	2 HP, 115 Volts, 1 Phase 5 HP, 208-230/460 Volts, 3 Phase	7	\$1,730.00

### CONTROL PANELS

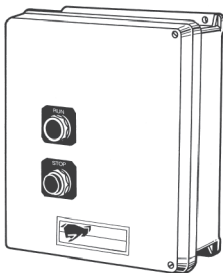
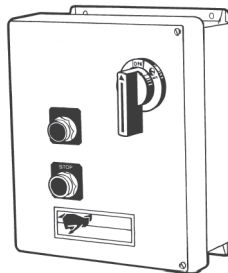
RAC1 Control Center  
Automatic ReversingRAC2 Control Center  
Automatic Reversing

- NEMA4X Watertight Fiberglass Enclosure
  - Reversing Magnetic Contactor
  - Low Voltage Solid State Control Circuit
  - Series "F", "C" & "B" Series have thermal protector on motor
  - Terminal Connection for 24 Volt Solenoid Valve
  - RAC1 – Start-Stop Buttons on Front Door
  - RAC2 – Illuminated Start-Stop Buttons on Front Door
  - RAC2 – Emergency Disconnect Switch
  - Time Delay 2 Minute Clean Out Cycle
- Specify HP, Voltage and Phase when ordering*

MODEL NO.	DESCRIPTION	SHIP WT. LBS.	LIST PRICE
RAC1	½ to 5 HP Range for "F", "C" & "B" Series Disposers (without overload relay)	20	\$1,735.00
RAC1	For all "C" & "B" Series Disposers (with overload relay)	20	\$2,103.00
RAC2	½ to 5 HP Range for "F", "C" & "B" Series Disposers (without overload relay)	20	\$2,552.00
RAC2	For all "C" & "B" Series Disposers (with overload relay)	20	\$2,917.00
EM	Conserves water and electricity usage by limiting disposer run time to a preset interval. Specify 5 to 15 minutes. <i>Available for RAC1 and RAC2 series controls only.</i>	–	No Charge



**REMOTE START-STOP SWITCH**

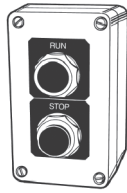

RS Remote Start-Stop Switch

- For RAC1 and RAC2 Control Centers

MODEL NO.	DESCRIPTION	SHIP WT. LBS.	LIST PRICE
RS	<b>Remote NEMA4X Watertight Start-Stop Switch:</b> Allows panel to be located at a distance away while Start-Stop Switch can be mounted near disposer. Includes remote circuitry in panel and NEMA4X watertight remote switch.	4	\$523.00
PF	<b>Positive Flush:</b> After motor stops, water continues running for 2 minutes, flushing waste chamber and drainline.	-	No Charge

**WATERFLOW COMPONENTS: Included with every Master Disposers Mounting Assembly**

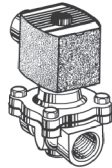

Solenoid Valve



Vacuum Breaker



Water Flow Control Valve

MODEL NO.	DESCRIPTION	SHIP WT. LBS.	LIST PRICE
<b>SOLENOID VALVE (Specify Coil Voltage when ordering)</b>			
05-5-154	1/2" Pipe Size, 24 Volt Coil (Must be used with RAC1 and RAC2)	2	\$298.00
05-5-152	1/2" Pipe Size, 120 Volt Coil	2	\$298.00
05-5-155	1/2" Pipe Size, 208 Volt Coil	2	\$298.00
05-5-151	1/2" Pipe Size, 240 Volt Coil	2	\$298.00
05-5-153	1/2" Pipe Size, 480 Volt Coil	2	\$298.00
05-5-154H	3/4" Pipe Size, 24 Volt Coil (Must be used with RAC1 and RAC2)	2	\$384.00
<b>VACUUM BREAKER</b>			
10-5-201	1/2" Pipe Size	2	\$145.00
10-5-202	3/4" Pipe Size	2	\$193.00
<b>WATER FLOW CONTROL VALVE</b>			
10-H-303	1/2" Pipe Size, 3 GPM	2	\$132.00
10-AB-308	3/4" Pipe Size, 8 GPM	2	\$174.00
10-C-310	3/4" Pipe Size, 10 GPM	2	\$185.00



**DISPOSER OPTIONS AND ADAPTOR KITS**

DESCRIPTION	LIST PRICE
<b>HARD CHROME OPTION "HC"</b>	
For Hard Chrome Option (on "C" Series), add HC to the end of disposer model number <i>Add</i>	"C" SERIES \$477.00
<b>3/4" SOLENOID VALVE OPTION</b>	
Only available in 24 volt solenoid valves <i>Add</i>	- \$84.00
<b>3/4" VACUUM BREAKER OPTION</b>	
Available in all mounting assembly options <i>Add</i>	- \$47.00
<b>CORRECTIONAL FACILITY OPTION "CP"</b>	
Special features to meet correctional facility requirements. Standard package with tamper proof fasteners and Disposer THROAT RESTRICTOR Plate. Add CP to model number. Other correctional options available. Call factory for details.	DISPOSER MOUNTING CONTROL \$157.00
	\$157.00
	\$157.00
<b>ADAPTOR KITS</b>	
Adaptor Kits are available to allow installation of a Master Disposer to virtually any sink or cone size or configuration.	MULTIPLE RING TYPE \$221.00
<b>Note:</b> Part nos. 06-5-846 & 06-5-847 are Band Type	BAND TYPE \$43.00

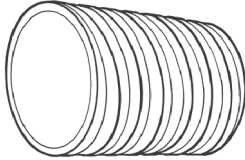
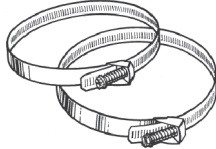
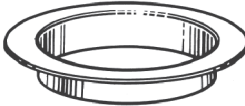
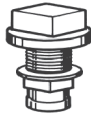
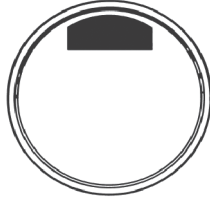

## DISPOSER ACCESSORIES

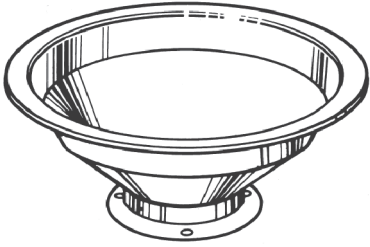
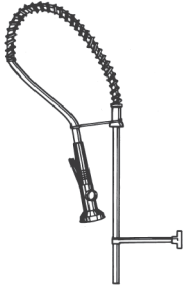
MODEL NO.	DESCRIPTION	SHIP WT. LBS.	LIST PRICE
<b>VINYL SILVER TRAP SCRAPPING RING</b>			
	 <ul style="list-style-type: none"> <li>• Reduces Silverware Loss</li> <li>• Reduces Disposer Backsplash</li> </ul>		
H-391	8 $\frac{1}{4}$ " Neoprene Silver Saver	3	\$227.00
<b>NEOPRENE CONNECTOR SLEEVE</b>			
	 <ul style="list-style-type: none"> <li>• Provides a Dampening Shock-Absorbing Disposer Connection</li> </ul>		
G-554	8 $\frac{1}{4}$ " x 9" Sleeve	3	\$143.00
<b>STAINLESS STEEL CLAMPS</b>			
	 <ul style="list-style-type: none"> <li>• Securely Fastens Neoprene Connector Sleeve to both Disposer and Cone/Sink</li> <li>• Features Quick Disconnect Design</li> </ul>		
A-3000	Clamp – Stainless Steel	1	\$44.00
<b>SINK ADAPTOR</b>			
	 <ul style="list-style-type: none"> <li>• Provides a 1" All-Around Lip for Welding to Sink</li> <li>• Spun Stainless Steel</li> </ul>		
H-394	8 $\frac{1}{4}$ " Sink Adaptor	2	\$174.00
<b>WATER SWIRL INLET VALVE</b>			
	 <ul style="list-style-type: none"> <li>• Chrome Plated</li> <li>• Fixed Elbow Design Provides Water Swirl for Waste Feeding</li> </ul>		
10-5-701	$\frac{1}{2}$ " Tubing Size	1	\$101.00
<b>CONE COVER</b>			
	 <ul style="list-style-type: none"> <li>• Allows Waste Sorting</li> <li>• Further Reduces Splashback and Increases Work Area</li> </ul>		
30-5-212	Fits 12" Cone	4	\$210.00
30-5-215	Fits 15" Cone	4	\$220.00
30-5-218	Fits 18" Cone	5	\$235.00

<b>DISPOSER ACCESSORIES (continued)</b>			
<b>MODEL NO.</b>	<b>DESCRIPTION</b>	<b>SHIP WT. LBS.</b>	<b>LIST PRICE</b>
<b>CONE HOPPER</b>			
		<ul style="list-style-type: none"> <li>• Spun 16 Gauge Stainless Steel</li> <li>• 1" All-Around Top Lip for Welding into Stainless Steel Table</li> <li>• Includes Water Swirl Inlet Valve, Part #10-5-701</li> </ul>	
<b>30-H-124</b>	12" Cone, 4½" Throat Opening for F Series	<b>4</b>	<b>\$515.00</b>
<b>30-H-154</b>	15" Cone, 4½" Throat Opening for F Series	<b>6</b>	<b>\$557.00</b>
<b>30-H-184</b>	18" Cone, 4½" Throat Opening for F Series	<b>7</b>	<b>\$569.00</b>
<b>H-402</b>	12" Cone, 8¾" Throat Opening for C & B Series	<b>4</b>	<b>\$458.00</b>
<b>H-400</b>	18" Cone, 8¾" Throat Opening for C & B Series	<b>7</b>	<b>\$561.00</b>
<b>SPRAY RINSE WITH WALL BRACKET</b>			
		<ul style="list-style-type: none"> <li>• Chrome Plated Flat Deck Mount Design</li> <li>• Dual Lever Energy Efficient Control Permits Quick Water Temperature</li> <li>• Large Non-Slip Spray Valve</li> <li>• Spring Loaded Goose Neck with Storage Hook</li> <li>• Adjustable (from 2" to 6¾") Wall Bracket Provides Rigid Installation</li> </ul>	
<b>10-5-502</b>	Fisher Brand (No. 2110/2902)	<b>10</b>	<b>\$939.00</b>
<b>10-5-503</b>	T & S Brand (No. B-113/B-109)	<b>10</b>	<b>\$939.00</b>
<b>DEJAMMING WRENCH</b>			
		<ul style="list-style-type: none"> <li>• High Strength, Steel Welded Construction, Enamel Finish</li> <li>• Placement over Rotor Impact Bar, with Slight Manual Turning in Either Direction, will Loosen Jam</li> </ul>	
<b>30-5-220</b>	26" Long, 16" Wide Handle	<b>8</b>	<b>\$162.00</b>



## **MASTER DISPOSERS**

165 Independence Court, Lancaster, PA 17601  
800-237-6628 ext. 173 • Fax: 717-299-4131  
*[www.masterdisposers.com](http://www.masterdisposers.com)*